

Схема сборки рам высотой 1,5м

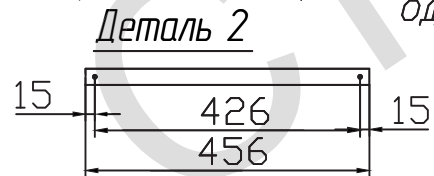

Примечание.
Для рам 400: связь
(поз. 3) ставится
одиночным отверстием вниз.

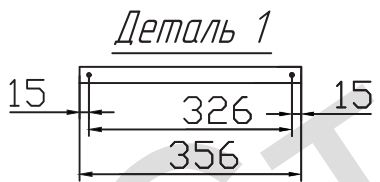
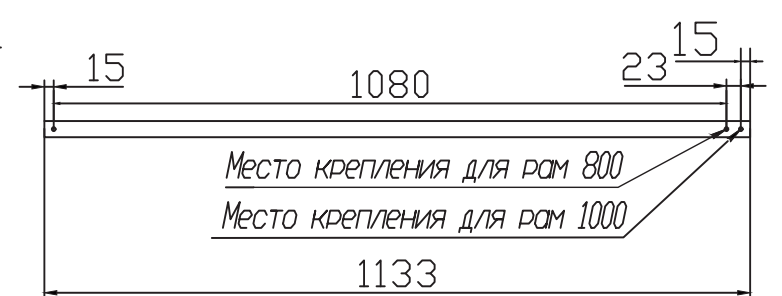
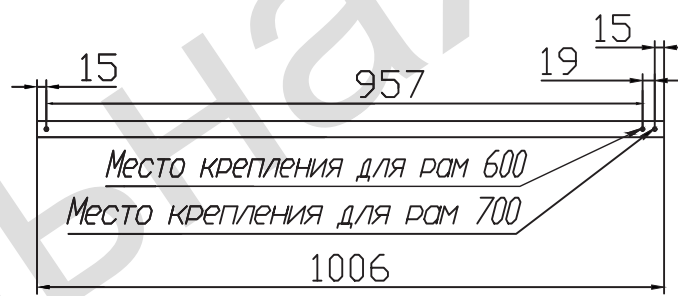
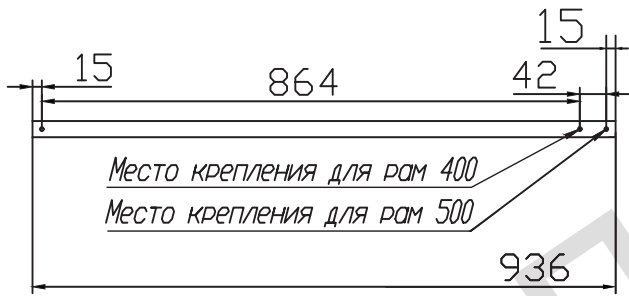
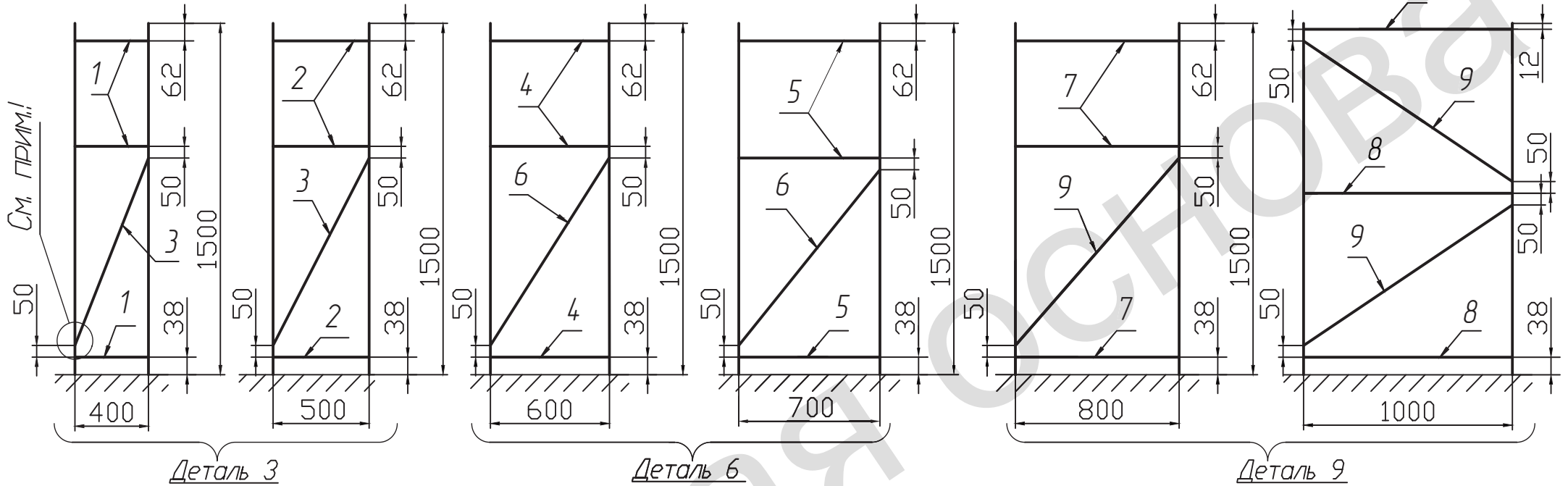

Схема сборки рам высотой 2м



Деталь 1

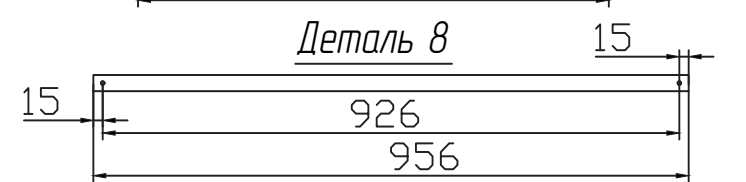
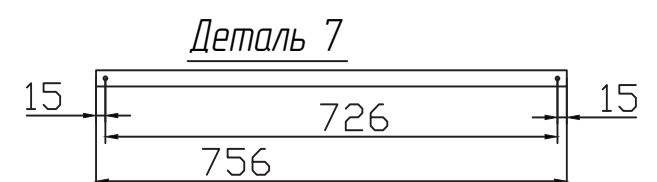
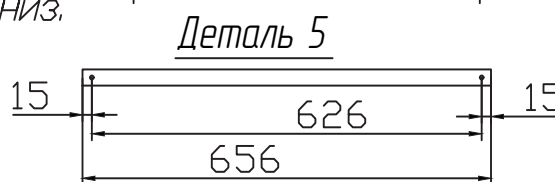
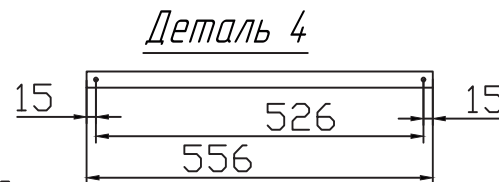
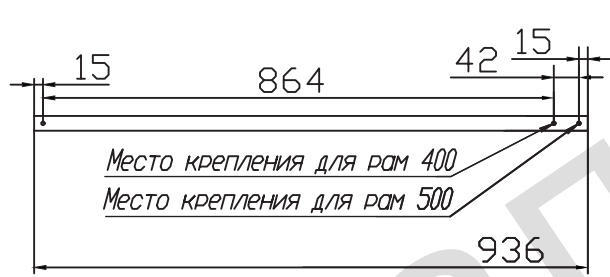
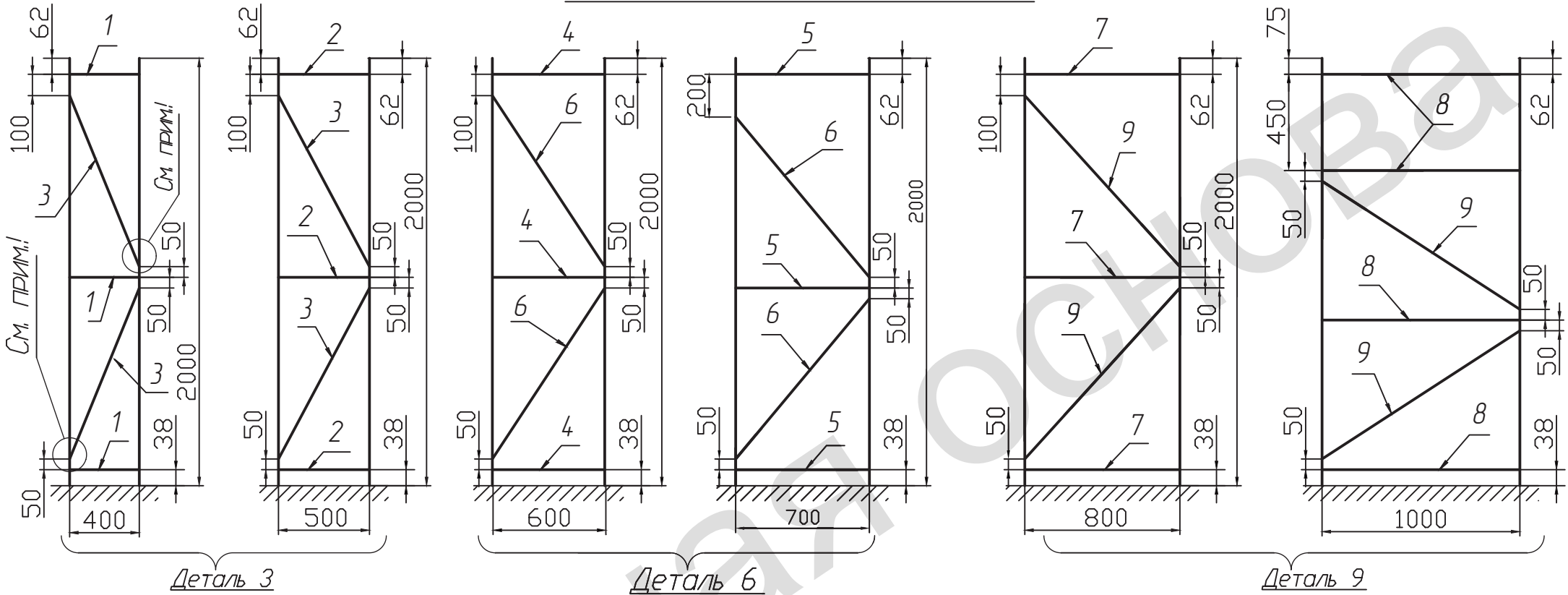
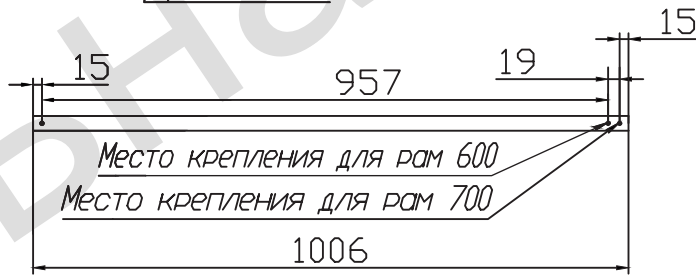

Деталь 4

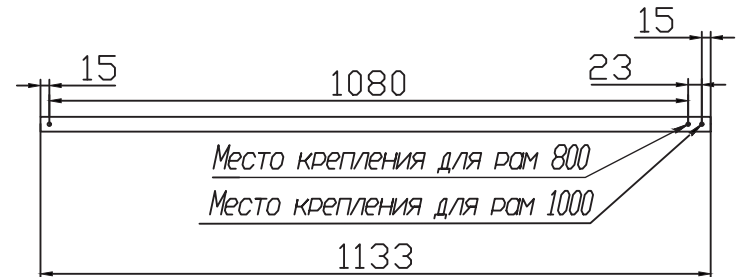

Деталь 7

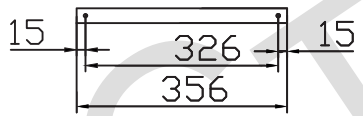

Деталь 2

Примечание.
Для рам 400: связи (поз. 3)
ставятся одиночным
отверстием вниз.

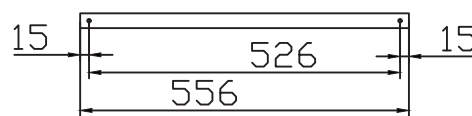

Деталь 5

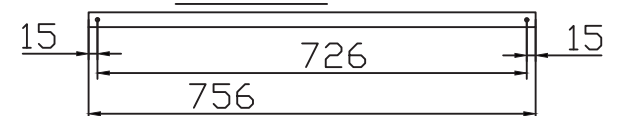

Деталь 8



Схема сборки рам высотой 2,5м



Примечание.
Для рам 400: связи (поз. 3)
ставятся одиночным
отверстием вниз.

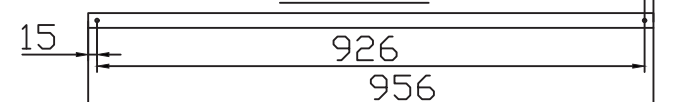
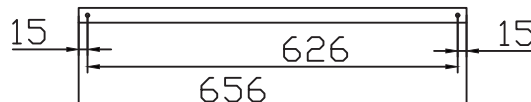
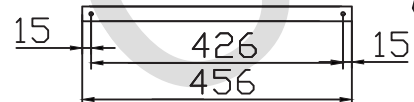
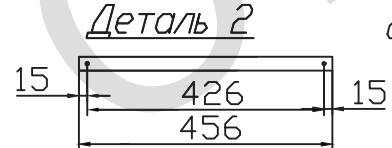
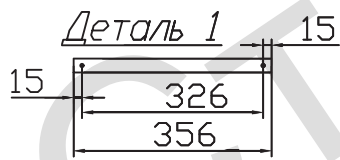
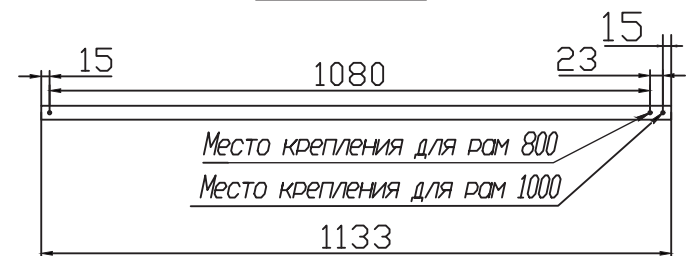
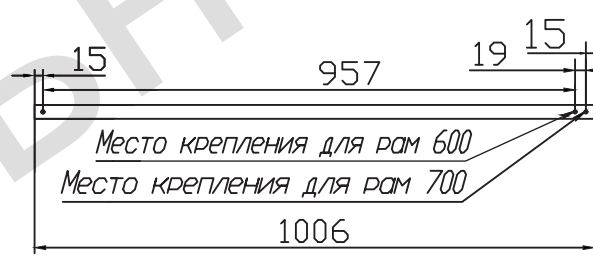
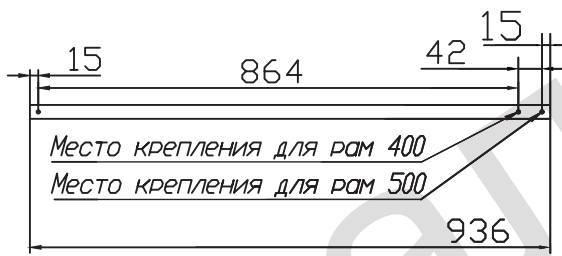
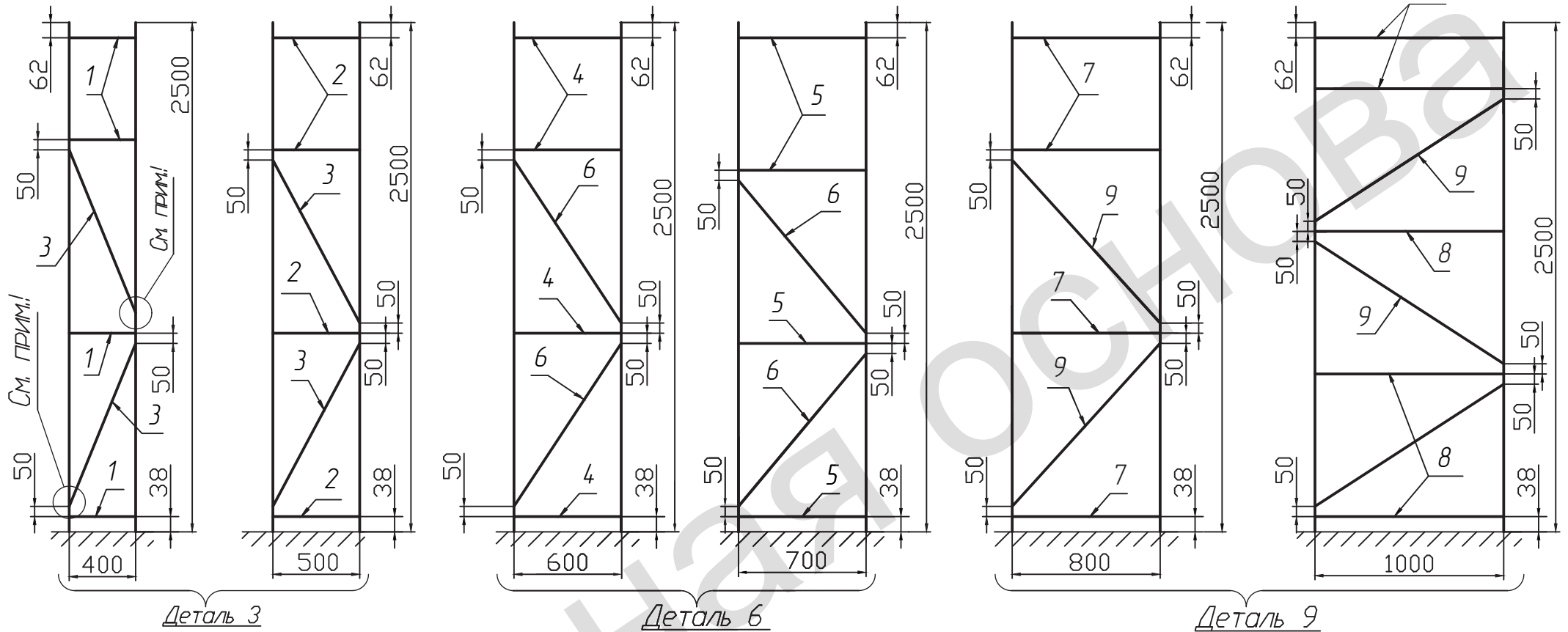

Схема сборки рам высотой 3м



Деталь 3

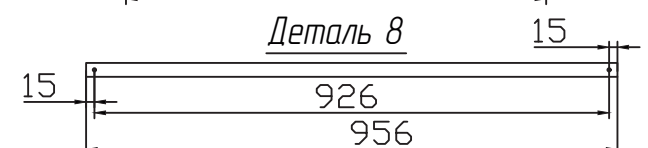
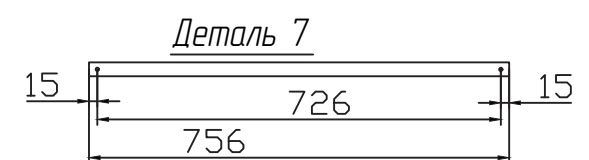
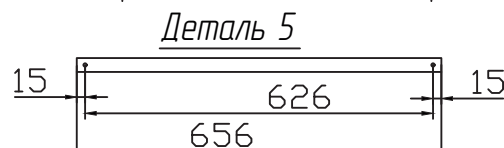
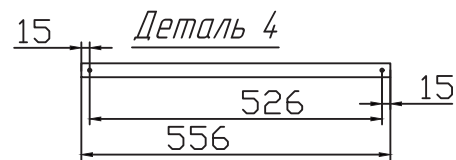
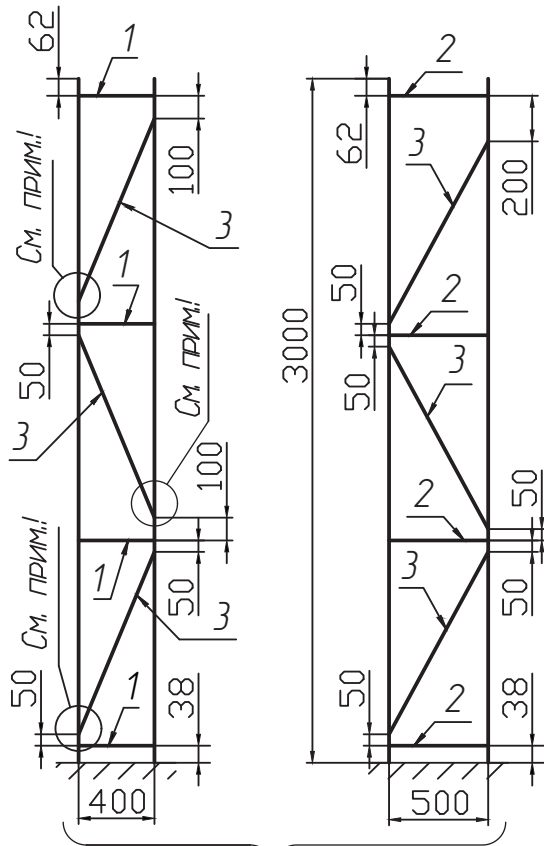
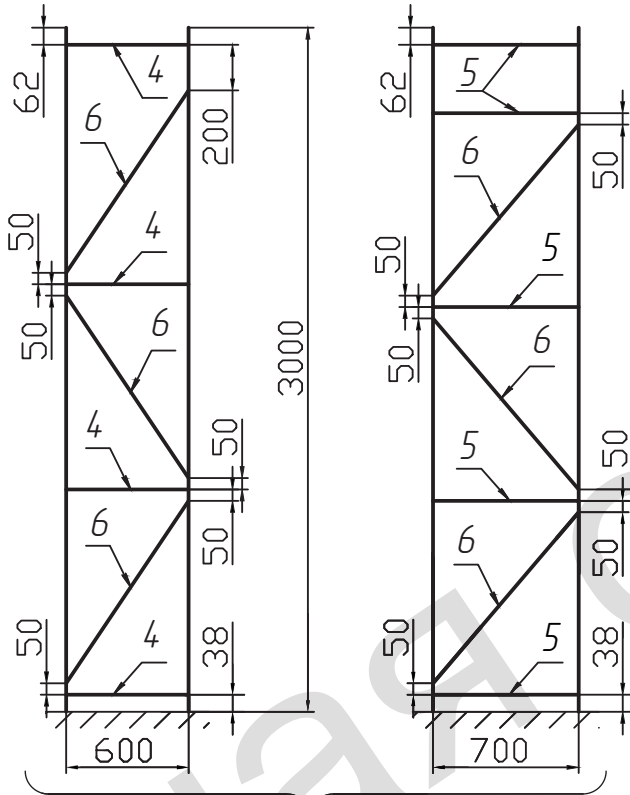

Деталь 6

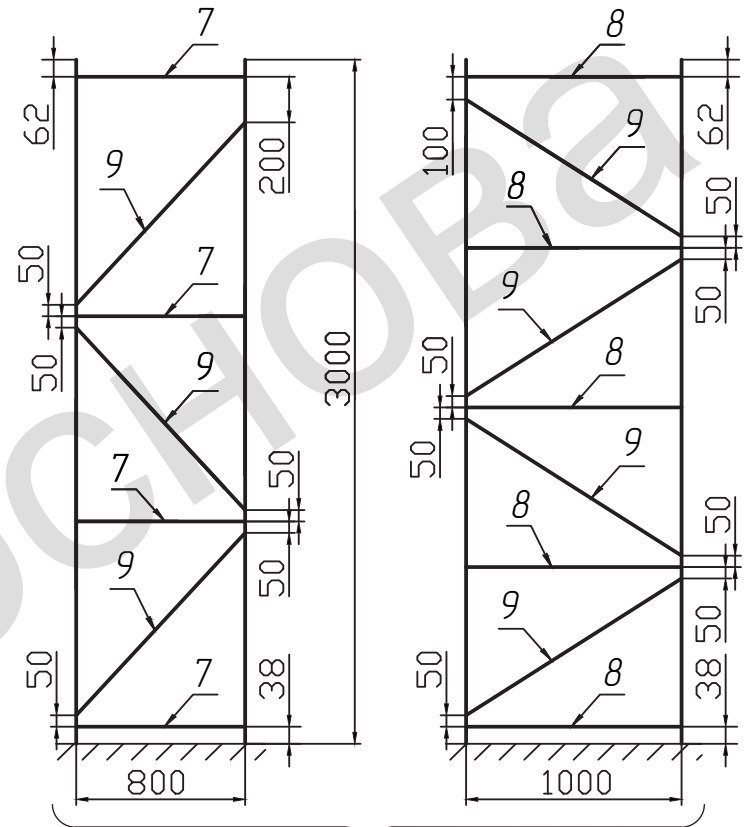

Деталь 9

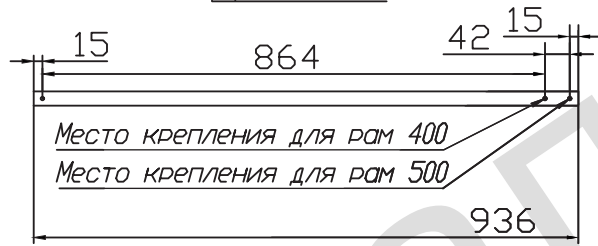

Деталь 1

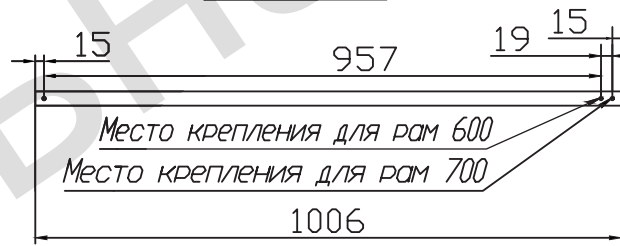

Деталь 4

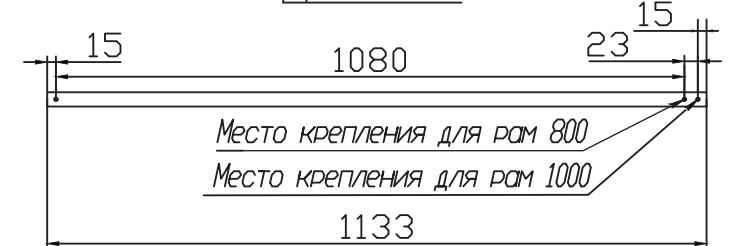

Деталь 7

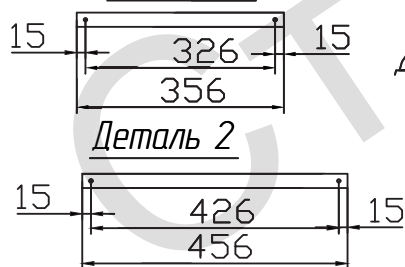

Деталь 2

Примечание.
Для рам 400: связи (поз. 3)
ставятся одиночным
отверстием вниз.

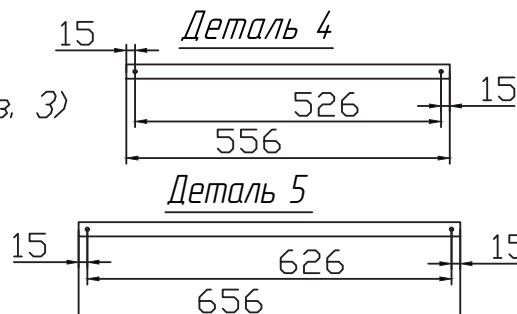

Деталь 5

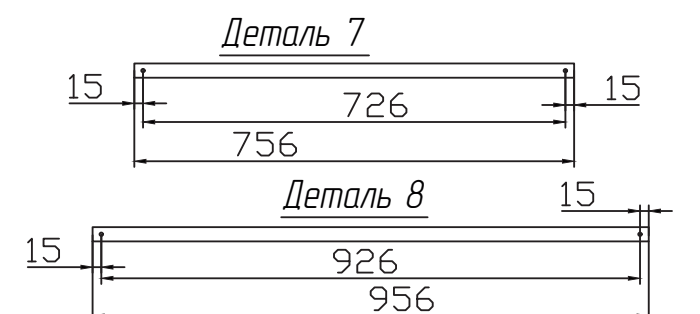

Деталь 8

Схема сборки рам высотой 3,5м

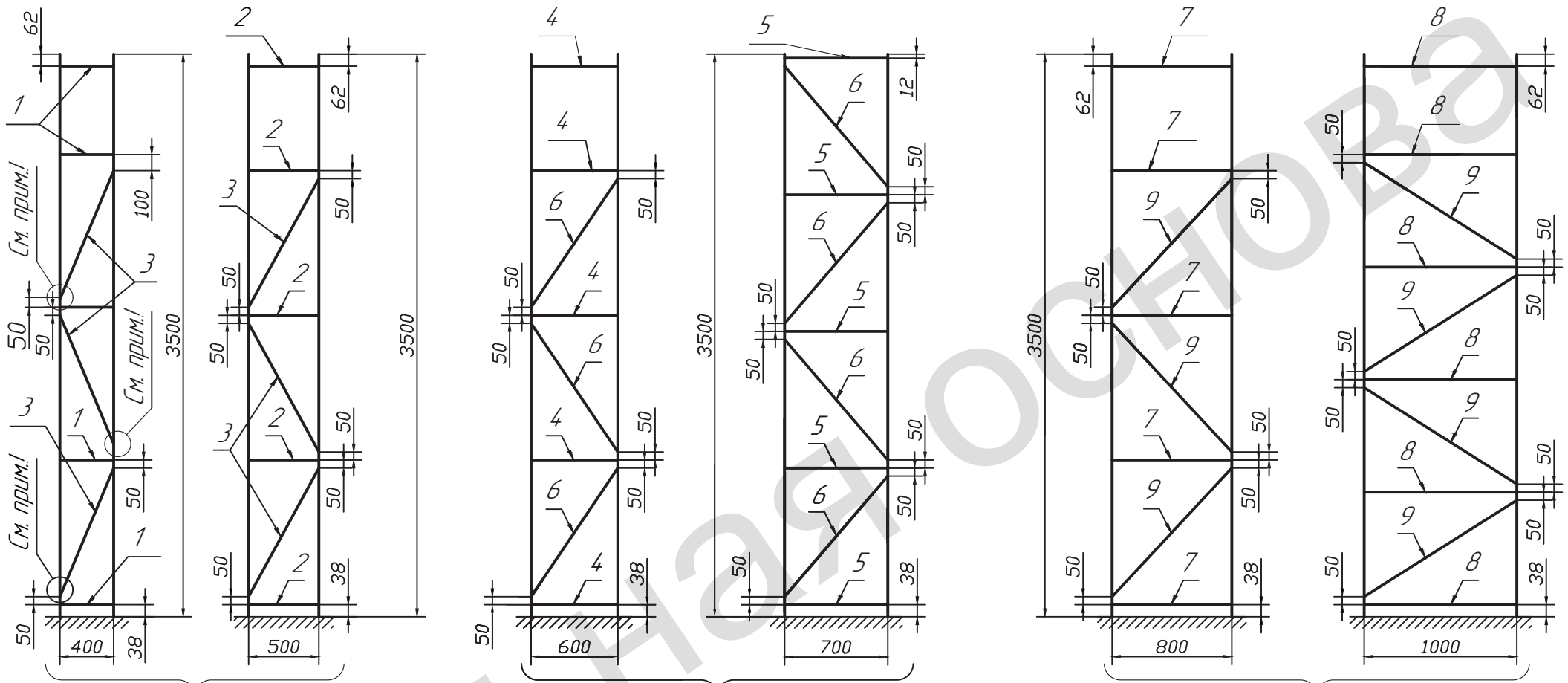

Деталь 3

Деталь 6

Деталь 9

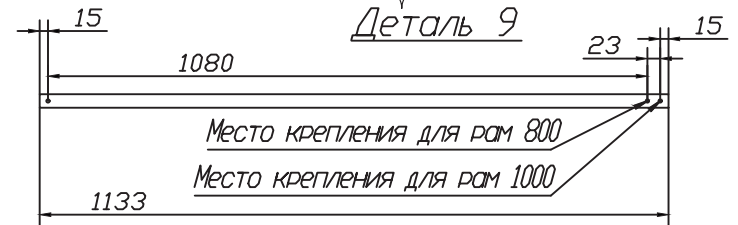
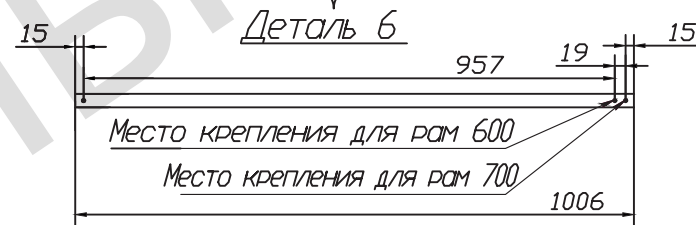
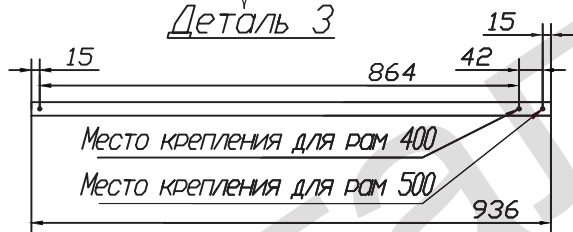

Деталь 1

Деталь 2

Деталь 4

Деталь 5

Деталь 7

Деталь 8

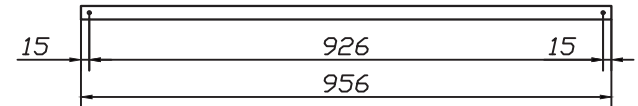
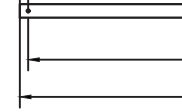
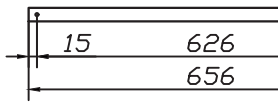
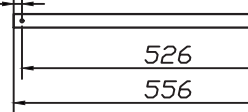
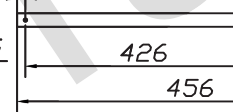
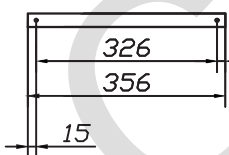

Примечание.

Для рам 400: связи (поз.3) ставятся одиночным отверстием вниз.

